

Product Specification

Product Code: VPT7A1

Product	TO-46 Packaged UV-LED with Lenz and Zener 300 nm
Title	Product Specification
Document No.	NKSUV-AD01-0055
Version	0.0
Issue Date	Mar. 9, 2017

NIKKISO GIKEN Co., Ltd.

NKSUV-AD01-0055

Table of Contents

	Page
1. Product Description	3
2. Intended Use	3
3. Product Code	3
4. Absolute Maximum Ratings.....	3
5. Electrical and Optical Characteristics	3
6. Environmental Compliance.....	3
7. Electrostatic Discharge (ESD) Protection.....	3
8. Reference Data and Derating Curve	4
9. Outline Dimensions, Main Materials and Electric Circuit.....	6
10. Lead Connection	7
11. Serial Numbering Code	7
12. Packaging	8
13. Cautions.....	10

1. Product Description: TO-46 Packaged UV-LED with Lens and Electrostatic Discharge Protection Device.

2. Intended Use: Deep-ultraviolet light source.

Caution: This product can only be used as a deep-ultraviolet light source.

3. Product Code

Peak Wavelength	Product Code
300 nm	VPT7A1

4. Absolute Maximum Ratings

Parameter	Symbol	Unit	Absolute Maximum Ratings	Remark
Forward Current (DC)	I_F	mA	30	$T_c=25$ deg C
Forward Current (Pulse)	I_{FP}	mA	60	$T_c=25$ deg C PW<10 ms, Duty<10 %
Allowable Loss	P_D	mW	150	$T_c=25$ deg C
Reverse Voltage	V_R	V	5.0	$T_c=25$ deg C
Operating Temperature	T_{opr}	deg C	-10 to 85	-
Storage Temperature	T_{stg}	deg C	-40 to 100	-
Soldering Temperature	T_{sol}	deg C	260	2×5 sec Hand Soldering

T_c : Case temperature

5. Electrical and Optical Characteristics ($I_F=20$ mA, $T_c=25$ deg C)

Parameter	Symbol	Unit	Min.	Typ.	Max.	Remark
Forward Voltage	V_F	V	4.5	5.0	6.0	-
Peak Wavelength	λ_P	nm	295	300	305	-
Radiant Flux	P_O	mW	1.0	2.0	-	-
Spectrum Half Width (FWHM)	$\Delta\lambda$	nm	-	15	20	-
Viewing Angle	$2\theta_{1/2}$	deg.	-	7	-	-
Thermal Resistance	$R_{J.C}$	deg C / W	-	35	-	-

6. Environmental Compliance

This product is RoHS and REACH compliant.

7. Electrostatic Discharge (ESD) Protection

ESD protection device is built in this product.

ESD Protection Voltage Level: ± 2.0 kV (HBM, 1.5 k Ω , 100 pF)

8. Reference Data and Derating Curve

Note: All characteristics shown in this section are for reference only and are not guaranteed.

■ Forward Current vs Relative Radiant Flux

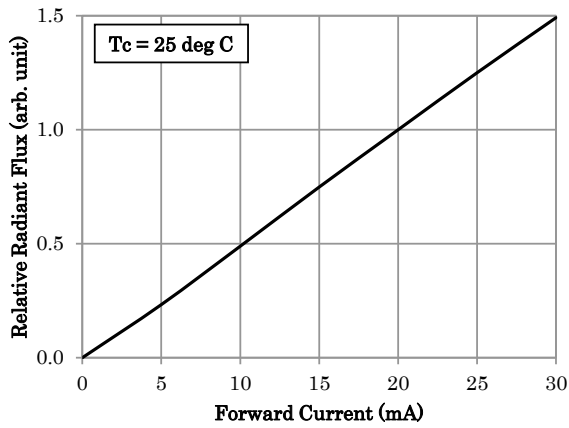

■ Forward Voltage vs Forward Current

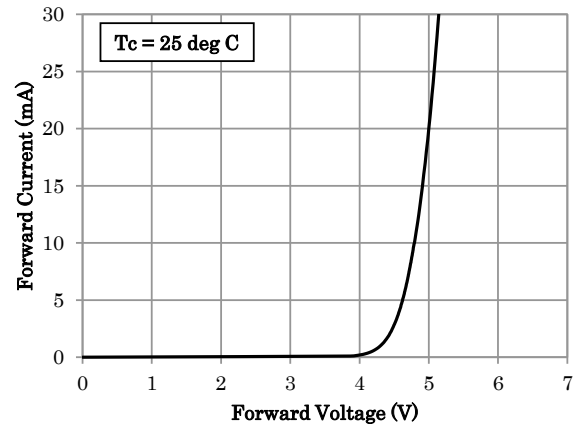

■ Case Temperature vs Relative Radiant flux

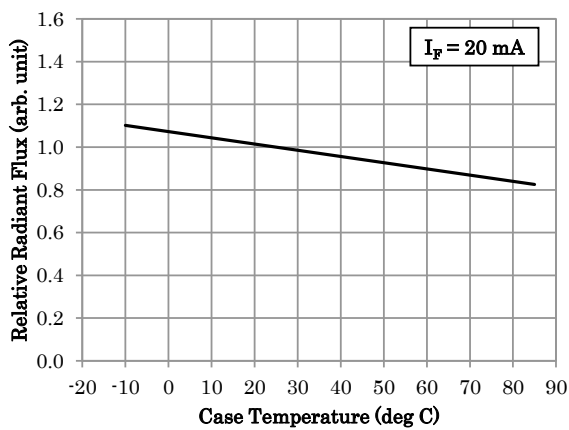

■ Case Temperature vs Forward Voltage

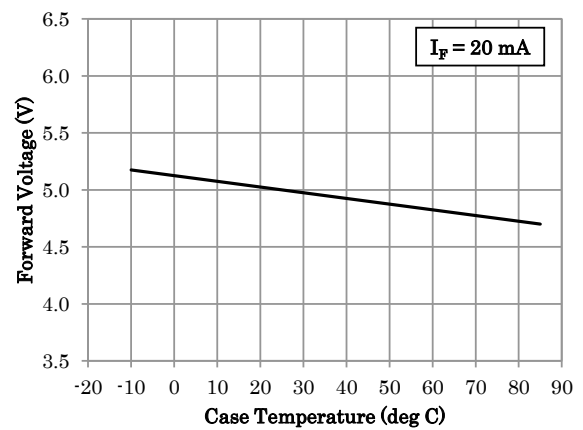

■ Case Temperature vs Peak Wavelength

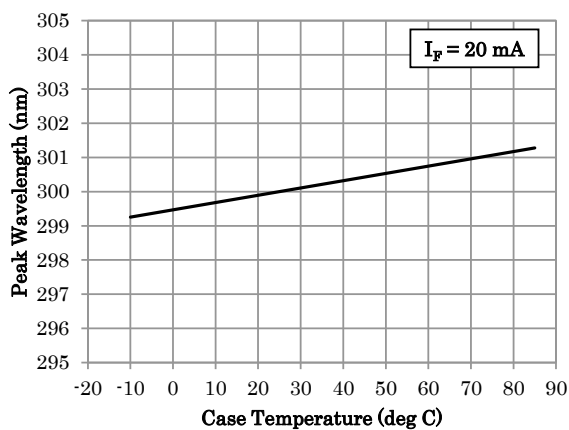

■ Spectrum

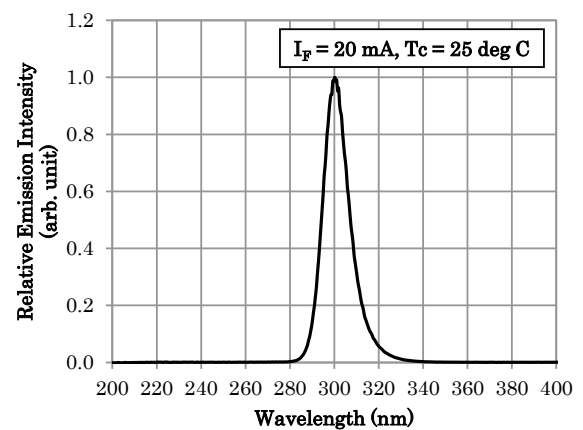

■ Directivity

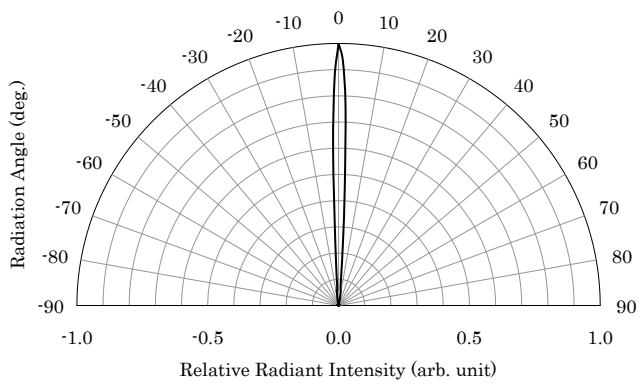

■ Derating Curve

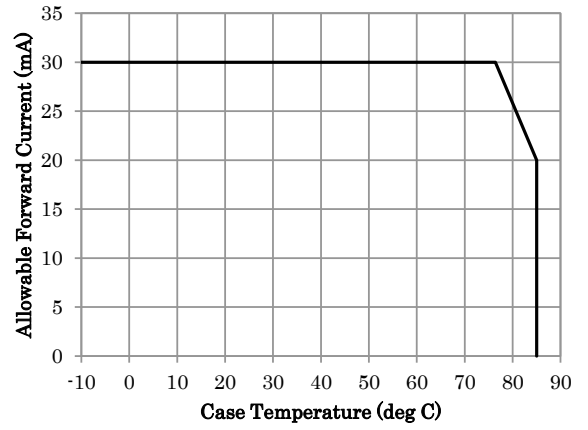

9. Outline Dimensions, Main Materials and Electric Circuit

Items	Materials
Glass Materials	UV-Glass
Cap Materials	Ni-plated Kovar
TO Header Materials	SPC
Lead Materials	Anode: Au-plated Iron-Nickel Alloy Cathode: Au-plated Kovar

(Unit: mm, Tolerance: ± 0.2)

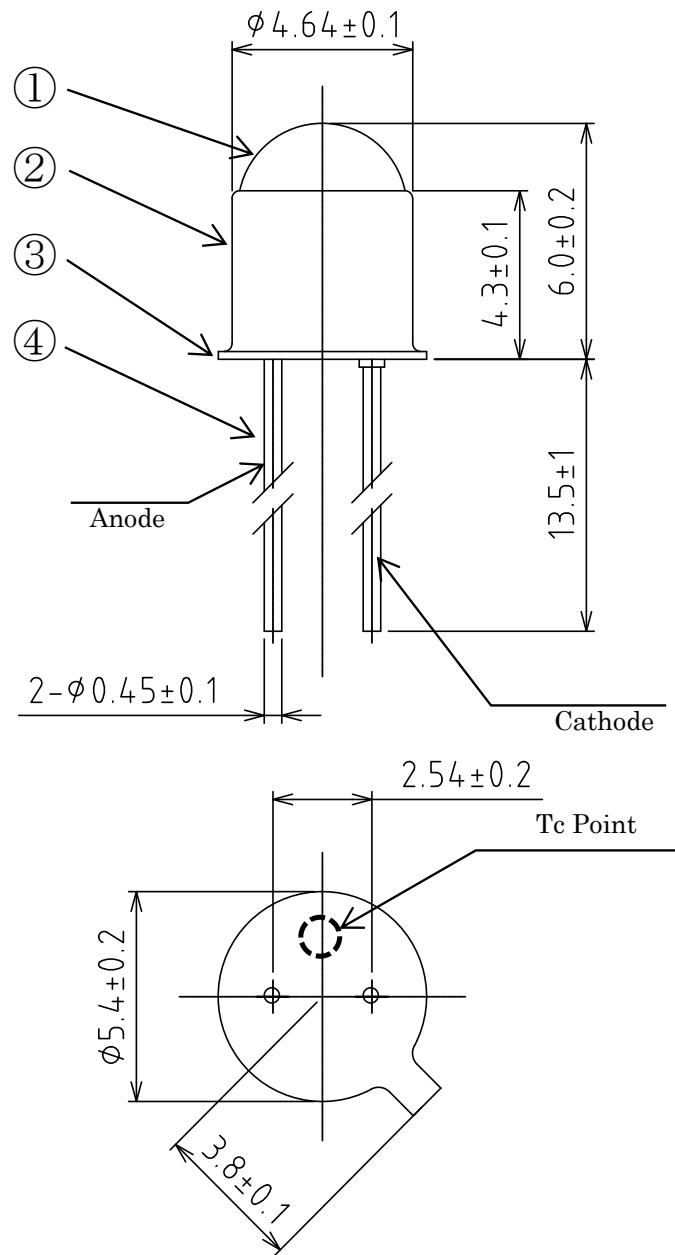

10. Lead Connection

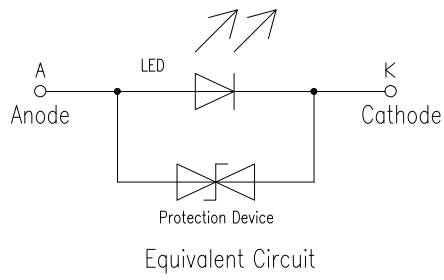

NOTE: This product should be operated in forward current

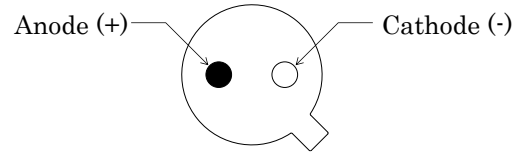

Back side view of this product.

11. Serial Numbering Code

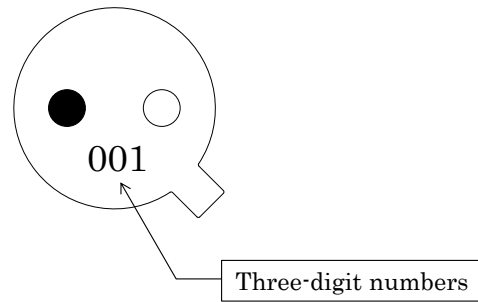
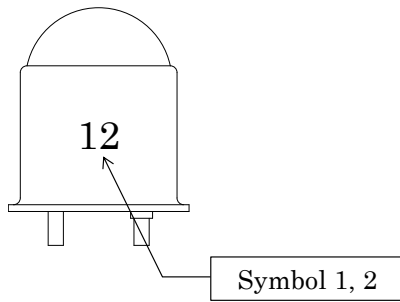

12. Packaging

- 1) Leads of the products are inserted and fixed in the anti-static polyethylene foam.
- 2) Up to 10 products can be put in a single moisture barrier bag.
- 3) Hazard warning labels are placed on the moisture barrier bags.
- 4) Up to 10 bags (100 pcs: 10 pcs × 10 bags) can be packed in a single shipping box.
- 5) Empty void space in the shipping box is filled with shock-absorbing materials.

NOTES: Do not drop or expose the shipping box to external forces.

Read "Cautions" chapter below before unpacking.

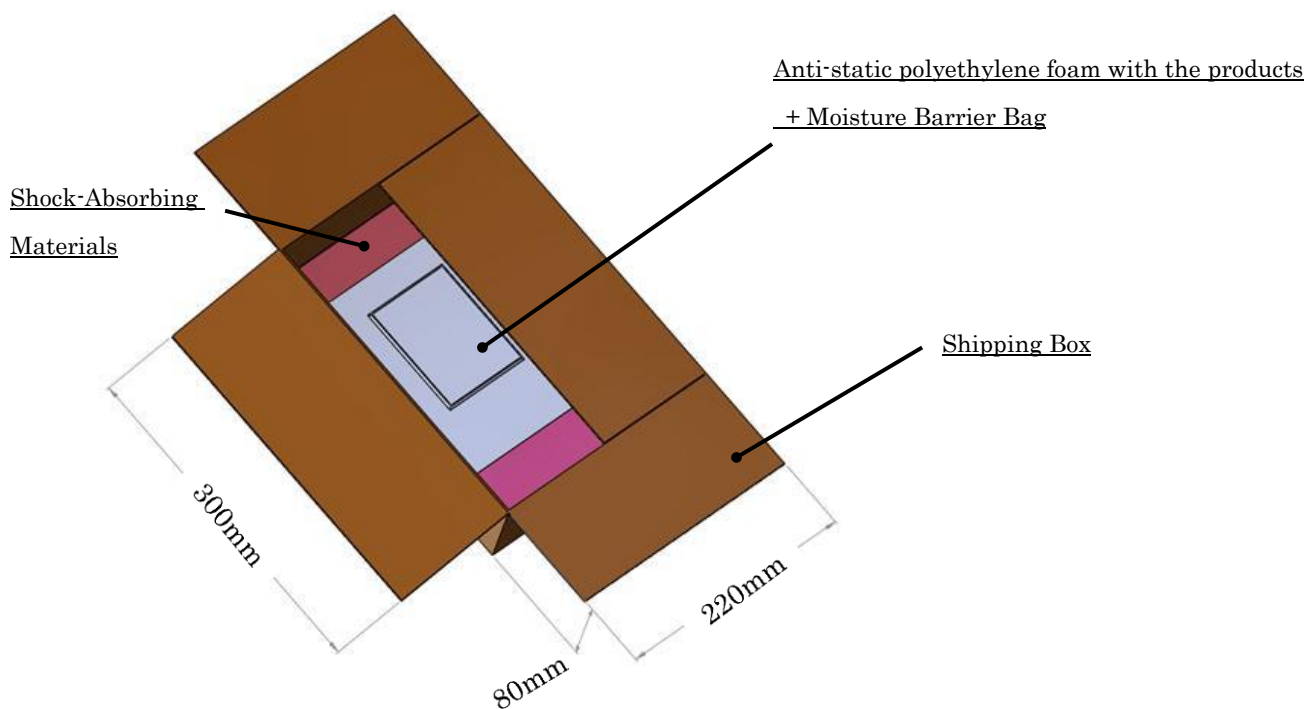

Specification of the shipping box.

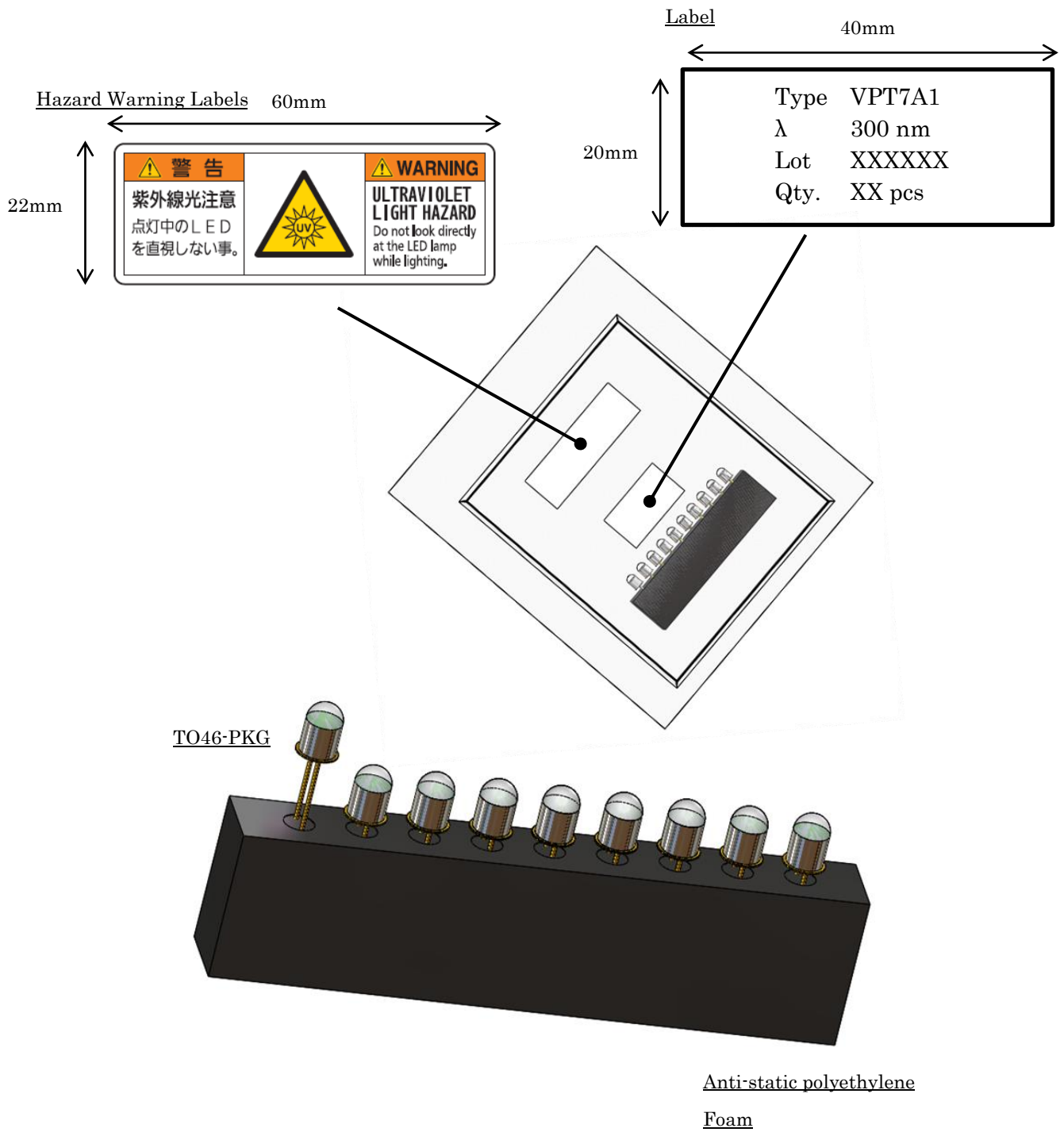

13. Cautions

- (A) The specifications described in this document are subject to change without prior notice.
- (B) Both the customer and Nikkiso will agree on the official specifications of supplied product before the volume production begins.

(C) Transportation

- 1) To avoid water condensation, do not expose the products to large temperature fluctuations.
- 2) Do not expose the cardboard box to water. It is not water-resistant.
- 3) In transportation, the use of packaging materials equivalent to that of our original shipment is recommended, in order to preserve the product quality.
- 4) Do not drop or expose the box to external forces as it may damage the products.

(D) Storage

- 1) The recommended storage conditions are as follows:

Storage	Temperature	Humidity	Period
Before opening moisture barrier bag	15 deg C ≤ T ≤ 30 deg C	RH ≤ 75 %RH	Within 6 months after arrival date
After opening moisture barrier bag	17 deg C ≤ T ≤ 28 deg C	RH ≤ 30 %RH (99 % N2 or Air is recommended)	Within 6 months after arrival date AND within 3 months after opening the bag

- 2) Storage conditions that exceed the recommended storage conditions may affect the characteristics of the products.
- 3) Exposure to corrosive atmosphere may cause the lead surface to corrode, tarnish, or discolor. This corrosion may cause difficulty during soldering operation.
- 4) Do not store the products in a dusty environment.
- 5) Do not expose the products to direct sunlight or an environment where the temperature is higher than the normal room temperature for a long period.

(E) Electrostatic Discharge (ESD)

- 1) Although it contains a built-in ESD protection device, this product is vulnerable to static electricity or surge voltage. Do not handle the products with bare hands and take appropriate measures against electrostatic discharge such as a grounded wrist strap and anti-static gloves.

(F) Handling

- 1) Do not handle the products with bare hands. It will contaminate the product surface and may affect the optical characteristics.
- 2) Do not stack assembled PCBs together. The impact may cause the products to be scratched, chipped, delaminated and/or deformed, affecting the optical characteristics. In the worst case, it may cause an open circuit and complete failure of the products.
- 3) Higher junction temperature may cause lowering product performance and/or product failure. Well-designed PCBs must be selected so as to properly dissipate the heat from the products.

(G) Ultraviolet (UV)

- 1) Do not look directly into the operating deep-ultraviolet LED as it may cause damage to the eyes. If looking into the operating LED is necessary, be sure to wear ultraviolet light protective glasses.
- 2) IEC62471 “Photobiological Safety of Lamps and Lamp Systems” defines exposure limits of electromagnetic radiation in the wavelength range from 200 nm to 3000 nm for each possible hazard (to the skin, eye, and retina). The deep ultraviolet light emitted from this product can be classified as belonging to the following hazards. It is recommended to understand the content of the standard before using the product.

Relevant Hazards

- Hazard to the skin
 - 4.3.1Es Actinic UV hazard exposure limit for the skin and eye
- Hazard to the eye (cornea)
 - 4.3.1Es Actinic UV hazard exposure limit for the skin and eye
 - 4.3.2Euva Near-UV hazard exposure limit for the eye
- Hazard to the retina
 - 4.3.3Lb Retina blue light hazard exposure limit
 - 4.3.4Eb Retina blue light hazard exposure limit – small source

(H) Others

- 1) This product is intended to be used for a general purpose (industry or consumer equipment) . Consult Nikkiso's sales staff in advance for information on more specialized applications in which higher quality is required (power plant application, submarine equipment, space equipment, aircraft equipment, medical equipment, transport equipment, emergency equipment etc.
- 2) The customer shall not reverse engineer by disassembling or analysis of the LEDs without having prior written consent from Nikkiso. When defective LEDs are found, the customer shall inform Nikkiso directly before disassembling or analysis.